

The logo for Gaviota Simbac features a white, stylized arch above the brand name. The arch is composed of two curved lines that meet at the top, resembling a bird's wing or a protective canopy. The text "Gaviota Simbac" is written in a clean, white, sans-serif font, centered horizontally beneath the arch.

Gaviota Simbac

Brazos Store / Balcony System / Store à Bras Droit / Braccio Store





SolarisS1 

Brazo Store.

Idóneo para cualquier tipo de balcón o baranda.

Ideal por su sencillez estética, de montaje y de utilización convirtiéndolo en una solución sencilla y eficaz.

Recomendado hasta una línea máxima de 6,00 m con 2 brazos.

Posibilidad de montaje con cofre NauticoN1 Premium y cofre DesertD1.

Balcony Arm.

It is the perfect awning for any type of balcony.

Effective and simple awning, very easy to assemble and use.

Recommended for up to 6,00 m width, with 2 arms.

Assembly option with Premium NauticoN1 box and DesertD1 box.

Bras Store.

Spécialement conçu pour balcons et balustrades.

Idéal grâce à sa simplicité esthétique, de montage et d'utilisation qui le convertit en une solution simple et efficace.

Recommandé jusqu'à 6,00 m de ligne, avec 2 bras.

Possibilité de montage avec coffre NauticoN1 Premium et coffre DesertD1.

Braccio Store.

Adatto per qualsiasi tipo di tenda a caduta applicata a finestra o balcone.

Ideale per la sua semplicità estetica, di montaggio e di utilizzo che la trasforma in una soluzione semplice ed efficace.

Consigliato per larghezza massima di 6,00 m con 2 bracci.

Possibilità di montaggio con cassonetto Nautico N1 Premium e cassonetto Desert D1.

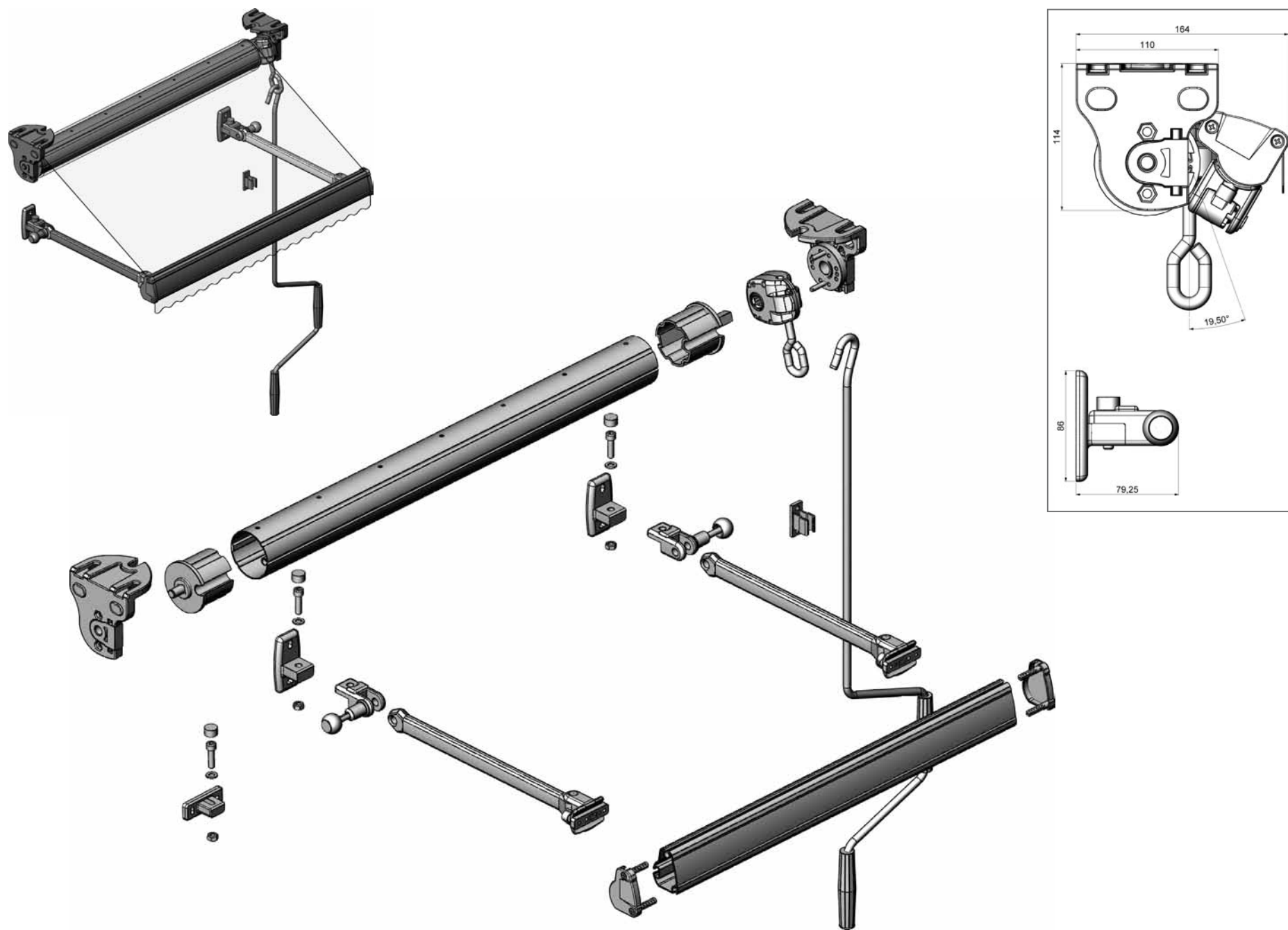

Despiece sistema / System parts / Système détaché / Esploso del sistema

Ejemplo para montaje Solaris, 3,00 m x 0,50 m (Línea x Salida). A barandilla. Color blanco
Assembly example for SolarisS1 with 3,00 m width and 0,50 m arms projection (balcony rail option). White colour
Exemple de montage Solaris, 3,00 m x 0,50 m (Largeur x Avancée). Couleur blanc
Esempio di montaggio Sistema Solaris, 3,00 x 0,50 m braccio. Nel colore bianco

Descripción / Description Description / Descrizione	Código / Code Code / Codice	Cantidad / Quantity Quantité / Quantità
Juego anclaje inyeccion caset sin espiga / Set of injection brackets without round pivot <i>Jeu de supports injection sans téton type cassette / Set supporti in pressofusione senza perno</i>	8004-176	1
Máquina Ciclon 1/7 cáncamo 90 mm acero zincado, roscada / Cyclon gear 1/7 90 mm eye, zinc steel, rolled <i>Treuil Cyclon 1/7 anneau 90 mm acier zingué, vissé / Arganello Ciclon 1/7 occhio L90 mm fori filettati</i>	8001-185	1
Tubo ranurado galvanizado / Galvanized round tube with ogive / Tube rond à gorge galvanisé / Rullo ogiva Ø 60mm	8003-5	4 m
Casquillo 60 mm ranurado de aluminio para máquina, espiga cuadrada 13x33 mm / Driving round cap of 60 mm with square pivot of 13x33 mm in aluminum <i>Embout mâle côté manoeuvre, sortie carrée 13x33 mm, en aluminium / Calotta ogiva Ø 60 mm in alluminio con perno quadro 13x33 mm</i>	8002-6	1
Casquillo 60 mm ranurado de aluminio para punto, espiga redonda 12x20 mm / Round cap of 60 mm with round pivot of 12x20 mm in aluminum <i>Embout mâle côté opposé, sortie ronde 12x20 mm, en aluminium / Calotta ogiva Ø 60 mm in alluminio perno Ø 12x20 mm</i>	8002-8	1
Juego de brazos stor (0,50 m) / Balcony arms set (0,50 m) / Jeu de bras store balcon (0,50 m) / Kit bracci store (sporgenza 0,50 m)	8007-7	1
Perfil Bambu 1 / Bambu1 profile / Profil Bambu1 / Profilo terminale in alluminio Bambu 1	8005-320	4 m
Juego de tapas perfil Bambu1 / Set of caps for Bambu1 profile / Jeu d'embouts pour profil Bambu1 / Kit tappi per profilo terminale Bambu 1	8005-328	1
Manivela extra lacada gancho zincado (1,50 m) / Lacquered handcrank, zinc plated steel hook (1,50 m) <i>Manivelle laquée crochet zingué (1,50 m) / Asta verniciata gancio zincato (1,50 m)</i>	8009-10	1
Pinza sujeta manivela de poliamida / Polyamide handle lock / Bloqueur de manivelle en polyamide / Ferma asta plastica	7010-39	1

En el sistema SolarisS1 no es recomendable el montaje con motor. Se puede montar a barandilla o pared.

The SolarisS1 system is not recommended to be motorized. It can be installed either to the balcony rail or to the wall.

Pour le système SolarisS1 le montage avec moteur n'est pas recommandé. On peut l'installer sur balcon ou mur.

Il sistema Solaris S1 non è raccomandabile con manovra a motore. Può essere montato sulla ringhiera e/o parete.

EN-13561:2004 Ábaco de resistencia al viento / Wind resistance selection abacus / Abaque de résistance au vent / Abaco resistenza al vento

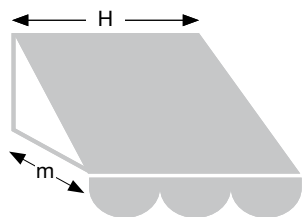

1,50	2,00	3,00	4,50	5,00	6,00	H m
3	3	3	3	3	3	0,50

- Clase 0** / Class 0 / Clase 0 / Classe 0
No cumple homologación / It does not fulfil the requirements / Il n'est pas homologué / Non è prevista omologazione.
- Clase 1** / Class 1 / Clase 1 / Classe 1
- Clase 2** / Class 2 / Clase 2 / Classe 2
- Clase 3** / Class 3 / Clase 3 / Classe 3
- IM Imposibilidad de montaje** / Impossible to assemble / Impossibilité de montage / Impossibile il montaggio

Resistencia al Viento / Wind Resistance / Résistance au Vent / Resistenza al Vento

Clase / Class Classe / Classe	Velocidad Máxima Viento / Maximum Wind Speed Vélocité Maximale Vent / Velocità Massima Vento	Presión / Pressure Pression / Pressione
1	28 Km/h	40 N/m ²
2	38 Km/h	70 N/m ²
3	49 Km/h	110 N/m ²

* **NOTA:** Las clases expuestas han sido obtenidas según las condiciones de ensayos descritos en los E.I.T. de Gaviota Simbac.

* **NOTE:** The different classes have been fulfilled according to the described conditions at Gaviota Simbac initial tests.

* **NOTE:** Le classement exposé a été obtenu suivant les conditions d'essais indiquées sur le manuel technique E.I.T. de Gaviota Simbac.

* **NOTA:** Le classi espote, sono state ottenute secondo le condizioni di prova descritte nel manuale E.I.T. di Gaviota Simbac.

SolarisS1

SolarisS1



**Descripción / Description
Description / Descrizione**

Juego de brazo stor.
Set of balcony arm.
Jeu de bras store balcon.
Kit bracci store.

Código / Code Code / Codice	L / m
8007-7	0,50
8007-49	0,50
8007-131	0,50
8007-127	0,50
8007-32	0,50
8007-31	0,50
8007-128*	0,50

Color / Colour Couleur / Colore
Blanco / White / Blanc / Bianco
Negro / Black / Noir / Nero
Plata / Silver / Argent / Argento
Bronce / Bronze / Bronzo
Burdeos / Dark red / Bordeaux
Verde / Green / Vert
Beige

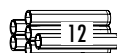

Perfil aluminio S1.
Aluminum profile S1.
Profil aluminium S1.
Profilo in alluminio S1 per braccio store.

8007-121	6
8007-123	6
8007-120	6
8007-118	6
8007-122	6
8007-124	6
8007-133*	6









Blanco / White / Blanc / Bianco
Negro / Black / Noir / Nero
Plata / Silver / Argent / Argento
Bronce / Bronze / Bronzo
Burdeos / Dark red / Bordeaux
Verde / Green / Vert
Beige

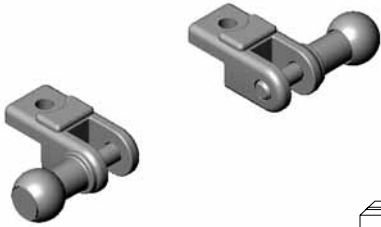

Terminal barandilla S1.
Balcony end terminal S1.
Embout final de bras S1.
Terminale in alluminio S1 per braccio store.

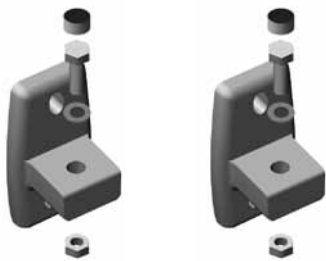
8007-86	
8007-88	
8007-129	
8007-90	
8007-87	
8007-89	
8007-92*	

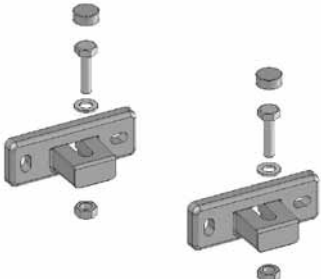
Blanco / White / Blanc / Bianco
Negro / Black / Noir / Nero
Plata / Silver / Argent / Argento
Bronce / Bronze / Bronzo
Burdeos / Dark red / Bordeaux
Verde / Green / Vert
Beige

	Descripción / Description Description / Descrizione	Código / Code Code / Codice	L / m	Color / Colour Couleur / Colore
 	<p>Juego soporte barandilla S1. <i>Set of balcony support S1.</i> <i>Jeu de platines support S1 sur barre d'appui.</i> <i>Kit aggancio S1 per braccio store.</i></p>	<p>8007-94 8007-96 8007-132 8007-98 8007-95 8007-97 8007-100*</p>		<p>Blanco / White / Blanc / Bianco Negro / Black / Noir / Nero Plata / Silver / Argent / Argento Bronce / Bronze / Bronzo Burdeos / Dark red / Bordeaux Verde / Green / Vert Beige</p>
 	<p>Juego terminal faldón S1. <i>Set of end terminal S1.</i> <i>Jeu de platines de liaison S1 sur barre de charge.</i> <i>Kit squadrette fissaggio S1 per braccio store.</i></p>	<p>8007-102 8007-104 8007-101 8007-106 8007-103 8007-105 8007-108*</p>		<p>Blanco / White / Blanc / Bianco Negro / Black / Noir / Nero Plata / Silver / Argent / Argento Bronce / Bronze / Bronzo Burdeos / Dark red / Bordeaux Verde / Green / Vert Beige</p>
 	<p>Juego soporte a pared S1 brazo stor. <i>Set of wall support S1 for balcony arms.</i> <i>Jeu support mural S1 store balcon.</i> <i>Kit fissaggio vert. a parete aggancio S1 per braccio store.</i></p>	<p>8007-110 8007-112 8007-109 8007-114 8007-111 8007-113 8007-116*</p>		<p>Blanco / White / Blanc / Bianco Negro / Black / Noir / Nero Plata / Silver / Argent / Argento Bronce / Bronze / Bronzo Burdeos / Dark red / Bordeaux Verde / Green / Vert Beige</p>
 	<p>Juego soporte a pared horizontal S1 brazo stor. <i>Set of horizontal wall support S1 for balcony arms.</i> <i>Jeu support mural horizontal S1 store balcon.</i> <i>Kit fissaggio orizz. a parete aggancio S1 per braccio store.</i></p>	<p>8007-139 8007-141 8007-140 8007-142 8007-144 8007-143 8007-145*</p>		<p>Blanco / White / Blanc / Bianco Negro / Black / Noir / Nero Plata / Silver / Argent / Argento Bronce / Bronze / Bronzo Burdeos / Dark red / Bordeaux Verde / Green / Vert Beige</p>